



OWNER'S MANUAL

Four-way Cassette Type

Thank you very much for purchasing our air conditioner,
Before using your air conditioner, please read this manual carefully and keep it for future reference.

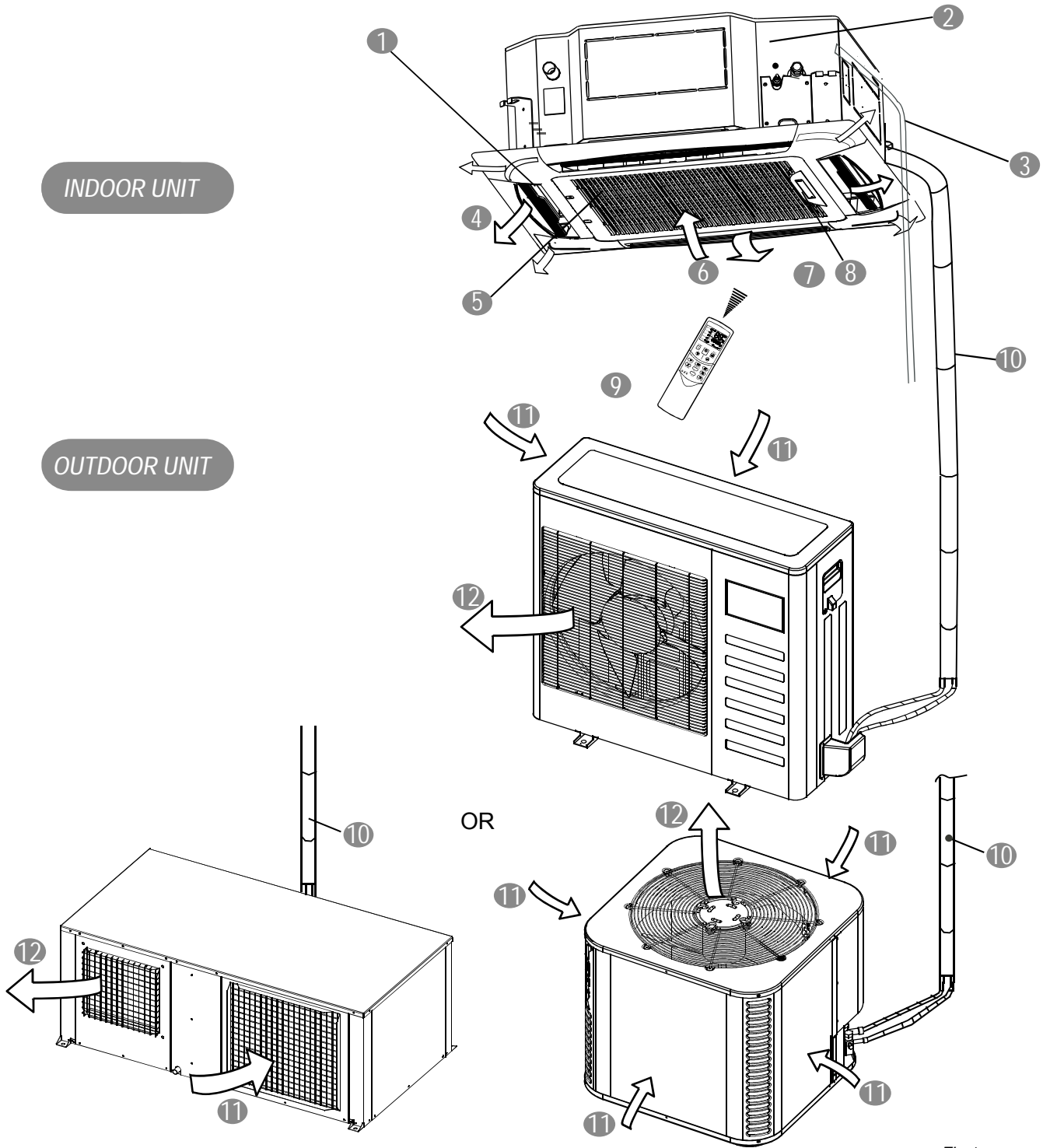

Fig.1

- | | | | |
|---|--|---|-------------------|
| ① | Air flow louver(at air outlet) | ⑦ | Air-in grill |
| ② | Drain pump(drain water from indoor unit) | ⑧ | Display panel |
| ③ | Drain pipe | ⑨ | Remote controller |
| ④ | Air outlet | ⑩ | Refrigerant pipe |
| ⑤ | Air filter(inside air-in grill) | ⑪ | Air inlet |
| ⑥ | Air inlet | ⑫ | Air outlet |



NOTE

All the pictures in this manual are for explanation purpose only. They may be slightly different from the air conditioner you purchased(depend on model).The actual shape shall prevail.

CONTENTS

PAGE

1.IMPORTANT SAFETY INFORMATION.....	1
2.PARTS NAMES.....	2
3.AIR CONDITIONER OPENRATIONS AND PERFORMANCE.....	2
4.HINTS FOR ECONOMICAL OPERATION.....	3
5.ADJUSTING AIR FLOW DIRECTION.....	3
6.MAINTENANCE.....	4
7.FOLLOWING SYMPTOMS ARE NOT AIR CONDITIONER TROUBLES.....	5
8.TROUBLESHOOTING.....	5

1. IMPORTANT SAFETY INFORMATION

To prevent injury to the user or other people and property damage, the following instructions must be followed. Incorrect operation due to ignoring of instructions may cause harm or damage.

The safety precautions listed are divided into two categories. In either case, important safety information is listed which must be read carefully.



WARNING

Failure to observe a warning may result in death. The appliance shall be installed in accordance with national wiring regulations.



CAUTION

Failure to observe a caution may result in injury or damage to the equipment.



WARNING

Ask your dealer for installation of the air conditioner.

Incomplete installation performed by yourself may result in a water leakage, electric shock, and fire.

Ask your dealer for improvement, repair, and maintenance.

Incomplete improvement, repair, and maintenance may result in a water leakage, electric shock, and fire.

In order to avoid electric shock, fire or injury, or if you detect any abnormality such as smell of fire, turn off the power supply and call your dealer for instructions.

Never let the indoor unit or the remote controller get wet. It may cause an electric shock or a fire.

Never press the button of the remote controller with a hard, pointed object. The remote controller may be damaged.

Never replace a fuse with that of wrong rated current or other wires when a fuse blows out.

Use of wire or copper wire may cause the unit to break down or cause a fire.

It is not good for your health to expose your body to the air flow for a long time.

Do not insert fingers, rods or other objects into the air inlet or outlet.

When the fan is rotating at high speed, it will cause injury.

Never use a flammable spray such as hair spray, lacquer or paint near the unit.

It may cause a fire.

Never touch the air outlet or the horizontal blades while the swing flap is in operation.

Fingers may become caught or the unit may break down.

Never put any objects into the air inlet or outlet.

Objects touching the fan at high speed can be dangerous.

Never inspect or service the unit by yourself.

Ask a qualified service person to perform this work.

Do not dispose this product as unsorted municipal waste. Collection of such waste separately for special treatment is necessary.

Do not dispose of electrical appliances as unsorted municipal waste, use separate collection facilities.

Contact you local government for information regarding the connection systems available.

If electrical appliances are disposed of in landfills or dumps, hazardous substances can leak into the groundwater and get into the food chain, damaging your health and well-being.

To prevent refrigerant leak, contact your dealer.

When the system is installed and runs in a small room, it is required to keep the concentration of the refrigerant, if by any chance coming out, below the limit. Otherwise, oxygen in the room may be affected, resulting in a serious accident.

The refrigerant in the air conditioner is safe and normally does not leak.

If the refrigerant leaks in the room, contact with a fire of a burner, a heater or a cooker may result in a harmful gas.

Turn off any combustible heating devices, ventilate the room, and contact the dealer where you purchased the unit.

Do not use the air conditioner until a service person confirms that the portion where the refrigerant leaks is repaired.



CAUTION

Do not use the air conditioner for other purposes.

In order to avoid any quality deterioration, do not use the unit for cooling precision instruments, food, plants, animals or works of art.

Before cleaning, be sure to stop the operation, turn the breaker off or pull out the supply cord.

Otherwise, an electric shock and injury may result.

In order to avoid electric shock or fire, make sure that an earth leak detector is installed.

Be sure the air conditioner is grounded.

In order to avoid electric shock, make sure that the unit is grounded and that the earth wire is not connected to gas or water pipe, lightning conductor or telephone earth wire.

In order to avoid injury, do not remove the fan guard of the outdoor unit.

Do not operate the air conditioner with a wet hand.
An electric shock may happen.

Do not touch the heat exchanger fins.
These fins are sharp and could result in cutting injuries.

Do not place items which might be damaged by moisture under the indoor unit.
Condensation may form if the humidity is above 80%, the drain outlet is blocked or the filter is polluted.

After a long use, check the unit stand and fitting for damage.
If damaged, the unit may fall and result in injury.

To avoid oxygen deficiency, ventilate the room sufficiently if equipment with burner is used together with the air conditioner.

Arrange the drain hose to ensure smooth drainage.
Incomplete drainage may cause wetting of the building, furniture etc.

Never touch the internal parts of the controller.
Do not remove the front panel. Some parts inside are dangerous to touch, and a machine trouble may happen.

Never expose little children, plants or animals directly to the air flow.
Adverse influence to little children, animals and plants may result.

Do not allow a child to mount on the outdoor unit or avoid placing any object on it.
Falling or tumbling may result in injury.

Do not operate the air conditioner when using a room fumigation - type insecticide.
Failure to observe could cause the chemicals to become deposited in the unit, which could endanger the health of those who are hypersensitive to chemicals.

Do not place appliances which produce open fire in places exposed to the air flow from the unit or under the indoor unit.
It may cause incomplete combustion or deformation of the unit due to the heat.

Do not install the air conditioner at any place where flammable gas may leak out.
If the gas leaks out and stays around the air conditioner, a fire may break out.

The appliance is not intended for use by young children or infirm persons without supervision.

This appliance can be used by children aged from 8 years and above and persons with reduced physical, sensory or mental capabilities or lack of experience and knowledge if they have been given supervision or instruction concerning use of the appliance in a safe way and understand the hazards involved. Children shall not play with the appliance. Cleaning and user maintenance shall not be made by children without supervision.

This appliance is not intended for use by persons (including children) with reduced physical, sensory or mental capabilities, or lack of experience and knowledge, unless they have been given supervision or instruction concerning use of the appliance by a person responsible for their safety.

Children should be supervised to ensure that they do not play with the appliance.

If the supply cord is damaged, it must be replaced by the manufacturer, its service agent or similarly qualified persons in order to avoid a hazard.

Do not operate your air conditioner in a wet room such as a bathroom or laundry room.

2. PARTS NAMES

The air conditioner consists of the indoor unit, the outdoor unit, the connecting pipe and the remote controller. (See Fig.2)

■ Function indicators on indoor unit display panel

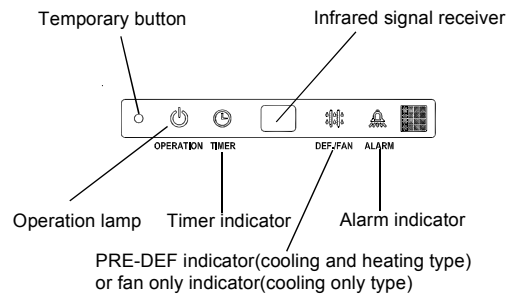

Display panel Fig.2-1

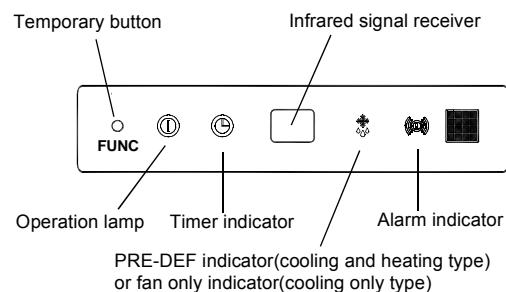

Display panel Fig.2-2

This function is used to operate the unit temporarily in case you misplace the remote controller or its batteries are exhausted. Two modes including AUTO and FORCED COOL can be selected through the TEMPORARY BUTTON on the air-in grill control box of the indoor unit. Once you push this button, the air conditioner will run in such order: AUTO, FORCED COOL, OFF, and back to AUTO.

- 1 AUTO
The OPERATION lamp is lit, and the air conditioner will run under AUTO mode. The remote controller operation is enabled to operate according to the received signal.
- 2 FORCED COOL
The OPERATION lamp flashes, the air conditioner will turn to AUTO after it is enforced to cool with a wind speed of HIGH for 30 minutes. The remote controller operation is disabled.
- 3 OFF
The OPERATION lamp goes off. The air conditioner is OFF while the remote controller operation is enabled.



NOTE

This manual does not include Remote Controller Operations, see the <<Remote Controller Owner's manual>> packed with the unit for details.

3. AIR CONDITIONER OPERATIONS AND PERFORMANCE

Use the system in the following temperature for safe and effective operation. The Max operation temperature for the air conditioner (Cooling/Heating).

Table 3-1(for inverter type air conditioner)

Temperature Mode	Outdoor temperature	Room temperature
Cooling operation	0°C ~ 50°C / 32 °F~122°F	17°C ~ 32°C (62 °F ~ 90°F)
	-15°C ~ 50°C / 5 °F~122°F (for the models with low temperature cooling system)	
Heating operation (cooling only type without)	-15°C ~ 24°C / 5 °F~76°F	0°C ~ 30°C / 32 °F~86°F
Dry operation	0°C ~ 50°C / 32 °F~122°F	17°C ~ 32°C (62 °F ~ 90°F)

Table 3-2

Temperature Mode	Outdoor temperature	Room temperature
Cooling operation	18°C ~ 43°C / 64 °F~109°F	17°C ~ 32°C (62 °F ~ 90°F)
	-7°C ~ 43°C / 20 °F~109°F (for the models with low temperature cooling system)	
	18°C ~ 52°C / 64 °F~126°F (for special tropical models)	
Heating operation (cooling only type without)	-7°C ~ 24°C / 20 °F ~ 76°F	0°C ~ 30°C / 32 °F~86°F
Dry operation	18°C ~ 43°C / 64 °F~109°F	17°C ~ 32°C (62 °F ~ 90°F)
	18°C ~ 52°C / 64 °F~126°F (for special tropical models)	



NOTE

- 1 If air conditioner is used outside the above conditions, it may cause the unit to function abnormally.
- 2 The phenomenon is normal that the surface of air conditioning may condense water when the relative larger humidity in room, please close the door and window.
- 3 Optimum performance will be achieved within these operating temperature range.

■ **Three-minute protection feature**

A protection feature prevents the air conditioner from being activated for approximately 3 minutes when it restarts immediately after operation.

■ **Auto-restart function**

- Power failure during operation will stop the unit completely.
- When the power restores, the OPERATION indicator on the indoor unit starts flashing. For the unit without Auto-restart feature, to restart the operation, push the ON/OFF button on the remote controller. For the unit with Auto-restart feature, the unit restarts automatically with all the previous settings preserved by the memory function.

■ **Refrigerant Leakage Detection(optional):**

With this new technology, the display area will appear 'EC' (if applicable) and the LED indication lamps continue flashing when the outdoor unit detects refrigerant leakage.

■ **Louver Angle Memory Function(optional):**

For some models, the machine is special designed with louver angle memory function. Power failure during operation or pressing the ON/OFF button on the remote controller will stop the unit completely. When the power restores or pressing the ON/OFF button on the remote controller again, the unit restarts automatically with the previous open angle of the horizontal louver by the memory function. So we strongly recommend that the open angle of the horizontal louver should not be set too small, in case the condensed water forms and drops from the horizontal louver. Press the Manual control button and the open angle of the horizontal louver will be restored to the standard angle.

4. HINTS FOR ECONOMICAL OPERATION

The following should be noticed to ensure an economical operation.

- Adjust the air flow louver properly and avoid direct air flow to room inhabitants.
- Adjust the room temperature properly for a comfortable environment. Avoid excessive heating or cooling.
- Prevent direct sunlight during cooling operation by using curtains or blinds.
- Ventilate often. Extended use requires special attention to ventilation.
- Keep doors and windows closed. If the doors and windows remain open, air will flow out of your room causing a decrease in the cooling or heating effect.
- Never place objects near the air inlet or the air outlet of the unit. It may cause deterioration in the effect or stop the operation.
- Set the timer .
- If you don't plan to use the unit for a long time, please take the batteries from the remote controller. When the power is on, some energy will be consumed, even if the air conditioner isn't in operation. So please disconnect the power to save energy.
- Keep the indoor unit and remote controller at least 1 m away from televisions, radios, stereos, and other similar equipment. Failing to do so may cause static or distorted pictures.
- A dirty air filter will reduce cooling or heating efficiency, please clean it once two weeks.

5. ADJUSTING AIR FLOW DIRECTION

While the unit is in operation, you can adjust the air flow louver to change the flow direction and naturalize the room temperature evenly. Thus you can enjoy it more comfortably.

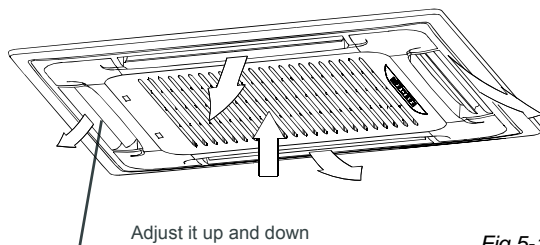

Fig 5-1

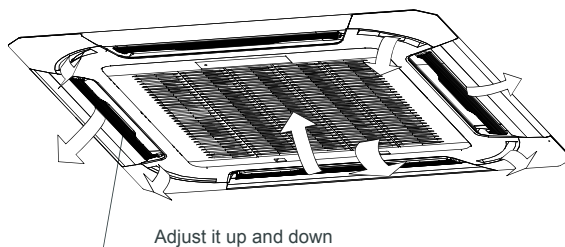

Fig 5-2

- **Set the air flow direction.**
Press the SWING button to adjust the louver to the desired position and press this button again to maintain the louver at this position.
- **Adjust the air flow direction automatically.**
Press the SWING button, the louver will swing automatically. While this function is set, the swing fan of indoor unit runs; otherwise, the swing fan doesn't run. The swing scale of every side is 30°. When the air conditioner isn't in operation (including when TIMER ON is set), the SWING button will be invalid.

6. MAINTENANCE



CAUTION

Before you clean the air conditioner, be sure the power supply is off.

Check if the wiring is not broken off or disconnected.

Use a dry cloth to wipe the indoor unit and remote controller.

A wet cloth may be used to clean the indoor unit if it is very dirty.

Never use a damp cloth on the remote controller.

Do not use a chemically-treated duster for wiping or leave such material on the unit for long. it may damage or fade the surface of the unit.

Do not use benzine, thinner, polishing powder, or similar solvents for cleaning. These may cause the plastic surface to crack or deform.

■ Maintenance after a long stop period

(eg. at the beginning of the season)

Check and remove everything that might be blocking inlet and outlet vents of indoor units and outdoor units.

Clean air filters and casings of indoor units. Refer to "Cleaning the air filter" for details on how to proceed and make sure to install cleaned air filters back in the same position.

Turn on the power at least 12 hours before operating the unit in order to ensure smoother operation. As soon as the power is turned on, the remote controller displays appear.

■ Maintenance before a long stop period

(eg. at the end of the season)

Let the indoor units run in fan only operation for about half a day in order to dry the interior of the units.

Clean air filters and casings of indoor units. Refer to "Cleaning the air filter" for details on how to proceed and make sure to install cleaned air filters back in the same position.

■ Cleaning the air filter

The air filter can prevent the dust or other particulate from going inside. In case of blockage of the filter, the working efficiency of the air conditioner may greatly decrease. Therefore, the filter must be cleaned once two weeks during long time usage.

If the air conditioner is installed in a dust place, clean the air filter frequent.

If the accumulated dust is too heavy to be cleaned, please replace the filter with a new one(replaceable air filter is an optional fitting).

1 Open the air-in grill

Push the grill switches towards the middle simultaneously as indicated in Fig.6-1. Then pull down the air-in grill.

The control box cables, which are originally connected with the main body electrical terminators must be pulled off before doing as indicated above.

2 Take out the air-in grill (together with the air filter shown in Fig.6-1).

Pull the air-in grill down at 45° and lift it up to take out the grill.

3 Dismantle the air filter.

4 Clean the air filter

Vacuum cleaner or pure water may be used to clean the air filter. If the dust accumulation is too heavy, please use soft brush and mild detergent to clean it and dry out in cool place.

- The air-in side should face up when using vacuum cleaner. (See Fig. 6-3)
- The air-in side should face down when using water. (See Fig. 6-4)



CAUTION

Do not dry out the air filter under direct sunshine or with fire.

5 Re-install the air filter.

6 Install and close the air-in grill in the reverse order of step 1 and 2 and connect the control box cables to the corresponding terminators of the main body.

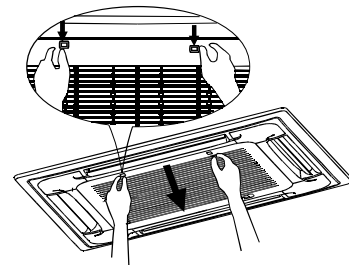

Fig.6-1

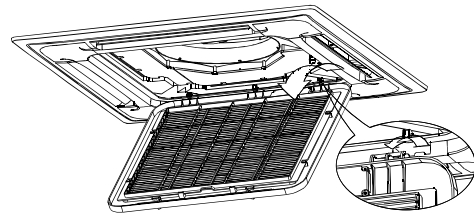

Fig.6-2

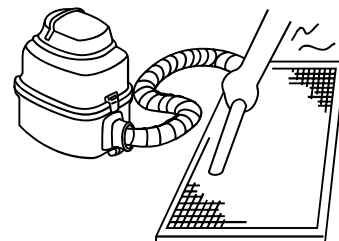

Fig.6-3

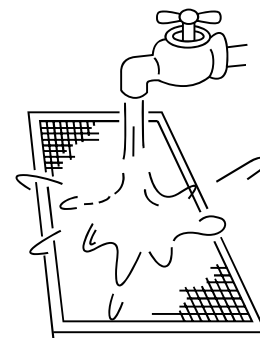

Fig.6-4

7. FOLLOWING SYMPTOMS ARE NOT AIR CONDITIONER TROUBLES

Symptom 1: The system does not operate

- The air conditioner does not start immediately after the ON/OFF button on the remote controller is pressed.
If the operation lamp lights, the system is in normal condition. To prevent overloading of the compressor motor, the air conditioner starts 3 minutes after it is turned ON.
- If the operation lamp and the "PRE-DEF indicator (cooling and heating type) or fan only indicator (cooling only type)" light, it means you choose the heating model. When just starting, if the compressor has not started, the indoor unit appears "anti cold wind" protection because of its overflow outlet temperature.

Symptom 2: Change into the fan mode during cooling mode

- In order to prevent the indoor evaporator frosting, the system will change into fan mode automatically, restore to the cooling mode after soon.
- When the room temperature drops to the set temperature, the compressor goes off and the indoor unit changes to fan mode; when the temperature rises up, the compressor starts again. It is same in the heating mode.

Symptom 3: White mist comes out of a unit

Symptom 3.1: Indoor unit

When humidity is high during cooling operation. If the interior of an indoor unit is extremely contaminated, the temperature distribution inside a room becomes uneven. It is necessary to clean the interior of the indoor unit. Ask your dealer for details on cleaning the unit. This operation requires a qualified service person.

Symptom 3.2: Indoor unit, outdoor unit

- When humidity is high during cooling operation. If the interior of an indoor unit is extremely contaminated, the temperature distribution inside a room becomes uneven. It is necessary to clean the interior of the indoor unit. Ask your dealer for details on cleaning the unit. This operation requires a qualified service person.
- When the system is changed over to heating operation after defrost operation. Moisture generated by defrost becomes steam and is exhausted.

Symptom 4: Noise of air conditioners cooling

Symptom 4.1: Indoor unit

- A continuous low "shah" sound is heard when the system is in cooling operation or at a stop.
When the drain pump (optional accessories) is in operation, this noise is heard.
- A "pishi-pishi" squeaking sound is heard when the system stops after heating operation.
Expansion and contraction of plastic parts caused by temperature change make this noise.

Symptom 4.2: Indoor unit, outdoor unit

- A continuous low hissing sound is heard when the system is in operation.
This is the sound of refrigerant gas flowing through both indoor and outdoor units.

A continuous low hissing sound is heard when the system is in operation.

This is the sound of refrigerant gas flowing through both indoor and outdoor units.

- A hissing sound which is heard at the start or immediately after stopping operation or defrost operation.
This is the noise of refrigerant caused by flow stop or flow change.

Symptom 4.3: Outdoor unit

- When the tone of operating noise changes.
This noise is caused by the change of frequency.

Symptom 5: Dust comes out of the unit

- When the unit is used for the first time in a long time.
This is because dust has gotten into the unit.

Symptom 6: The units can give off odours

- The unit can absorb the smell of rooms, furniture, cigarettes, etc., and then emit it again.

Symptom 7: The outdoor unit fan does not spin.

- During operation. The speed of the fan is controlled in order to optimize product operation.

8. TROUBLESHOOTING

8.1 Troubles and causes of air conditioner

If one of the following malfunctions occur, stop operation, shut off the power, and contact with your dealer.

- The operation lamp is flashing rapidly (5Hz).
This lamp is still flashing rapidly after turn off the power and turn on again. (See in Table 8-1a and Table 8-1b)
- Remote controller receives malfunction or the button does not work well.
- A safety device such as a fuse, a breaker frequently actuates.
- Obstacles and water enter the unit.
- Water leaks from indoor unit.
- Other malfunctions.

If the system does not properly operate except the above mentioned cases or the above mentioned malfunctions is evident, investigate the system according to the following procedures. (See in Table 8-2)

8.2 Troubles and causes of remote controller

Before asking for serving or repairing, check the following points. (See in Table 8-3)

Table 8-1a (Applicable to inverter air conditioner only)

NO.	Malfunction	running lamp	timer lamp	defrosting lamp	alarm lamp	display (nixie tube)
1	Collision model malfunction			Quick-flash		E0
2	In-outdoor unit communication checking channel is abnormal		Quick-flash			E1
3	Room temperature sensor checking channel is abnormal	Quick-flash				E2
4	Pipe temperature sensor (T2) checking channel is abnormal	Quick-flash				E3
5	Pipe temperature sensor (T2B) checking channel is abnormal	Quick-flash				E4
6	EEPROM malfunction			Quick-flash		E7
7	In door fan unit stall malfunction			Quick-flash	Quick-flash	E8
8	Outdoor unit malfunction				Slow-flash	Ed
9	Water-level alarm malfunction				Quick-flash	EE
10	Lifting panel communication checking channel is abnormal	Quick-flash		Quick-flash	Quick-flash	F0
11	Lifting panel malfunction		Quick-flash	Quick-flash	Quick-flash	F1
12	Lifting panel is not closed		On	Quick-flash	Quick-flash	F2
13	Indoor master/slave unit communication checking channel is abnormal		Quick-flash		Quick-flash	F3
14	Other malfunctions of master/slave unit	Quick-flash			Quick-flash	F4
15	Refrigerant leakage detection malfunction	On		Quick-flash	Quick-flash	EC

Table 8-1b (Applicable to fixed-frequency air conditioner only)

NO.	Malfunction	running lamp	timer lamp	defrosting lamp	alarm lamp	display (nixie tube)
1	In-outdoor unit communication checking channel is abnormal	Quick-flash		Quick-flash		E1
2	Room temperature sensor checking channel is abnormal		Quick-flash			E2
3	Evaporator sensor malfunction	Quick-flash				E3
4	Condenser sensor malfunction			Quick-flash		E4
5	Water pump temperature sensor				Quick-flash	E5
6	Outdoor malfunction	Quick-flash	Quick-flash	Quick-flash	Quick-flash	E6
7	EEPROM malfunction	Quick-flash	Quick-flash			E7
8	Water-level alarm malfunction				Quick-flash	E8
9	DC motor speed out of control		Quick-flash		Quick-flash	Eb
10	Outdoor unit low pressure malfunction	Quick-flash	Quick-flash	Quick-flash		Ed
11	Lifting panel communication checking channel is abnormal	Quick-flash		Quick-flash	Quick-flash	F0
12	Lifting panel malfunction		Quick-flash	Quick-flash	Quick-flash	F1
13	Lifting panel is not closed		On	Quick-flash	Quick-flash	F2
14	Refrigerant leakage detection malfunction	Quick-flash			Quick-flash	EC

Table 8-2

Symptoms	Causes	Solution
Unit does not start	<ul style="list-style-type: none"> Power failure. Power switch is off. Fuse of power switch may have burned. Batteries of remote controller exhausted or other problem of controller. 	<ul style="list-style-type: none"> Wait for the comeback of power. Switch on the power. Replace the fuse. Replace the batteries or check the controller.
Air flowing normally but completely can't cooling	<ul style="list-style-type: none"> Temperature is not set correctly. Be in 3 minutes protection of compressor. 	<ul style="list-style-type: none"> Set the temperature properly. Wait.
Units start or stop frequently	<ul style="list-style-type: none"> Refrigerant is too little or too much. Air or no concentering gas in the refrigerating circuit. Compressor is malfunction. Voltage is too high or too low. System circuit is blocked. 	<ul style="list-style-type: none"> Check leakage, and rightly recharge refrigerant. Vacuum and recharge refrigerant. Maintenance or change compressor. Install manostat.
Low cooling effect	<ul style="list-style-type: none"> Outdoor unit and indoor unit heat exchanger is dirty. The air filter is dirty. Inlet/outlet of indoor/outdoor units is blocked. Doors and windows are open Sunlight directly shine. Too much heat resource. Outdoor temp. is too high. Leakage of refrigerant or lack of refrigerant. 	<ul style="list-style-type: none"> Find reasons and solution. Clean the heat exchanger. Clean the air filter. Eliminate all dirties and make air smooth. Close doors and windows. Make curtains in order to shelter from sunshine. Reduce heat source. AC cooling capacity reduces (normal).
Low heating effect	<ul style="list-style-type: none"> Outdoor temperature is lower than 7°C . Doors and windows not completely closed. Leakage of refrigerant or lack of refrigerant. 	<ul style="list-style-type: none"> Check leakage and rightly recharge refrigerant. Use heating device. Close doors and windows. Check leakage and rightly recharge refrigerant.

Table 8-3

Symptoms	Causes	Solution
The fan speed can not be changed.	<ul style="list-style-type: none"> Check whether the MODE indicated on the display is "AUTO" 	When the automatic mode is selected, the air conditioner will automatically change the fan speed.
	<ul style="list-style-type: none"> Check whether the MODE indicated on the display is "DRY" 	When dry operation is selected, the air conditioner automatically change the fan speed. The fan speed can be selected during "COOL", "FAN ONLY", and "HEAT".
The remote controller signal is not transmitted even when the ON/OFF button is pushed.	<ul style="list-style-type: none"> Check whether the batteries in the remote controller are exhausted. 	The power supply is off.
The TEMP. indicator does not come on.	<ul style="list-style-type: none"> Check whether the MODE indicated on the display is FAN ONLY 	The temperature cannot be set during FAN mode.
The indication on the display disappears after a lapse of time.	<ul style="list-style-type: none"> Check whether the timer operation has come to an end when the TIMER OFF is indicated on the display. 	The air conditioner operation will stop up to the set time.
The TIMER ON indicator goes off after a lapse of certain time.	<ul style="list-style-type: none"> Check whether the timer operation is started when the TIMER ON is indicated on the display. 	Up to the set time, the air conditioner will automatically start and the appropriate indicator will go off.
No receiving tone sounds from the indoor unit even when the ON/OFF button is pressed.	<ul style="list-style-type: none"> Check whether the signal transmitter of the remote controller is properly directed to the infrared signal receiver of the indoor unit when the ON/OFF button is pressed. 	Directly transmit the signal transmitter of the remote controller to the infrared signal receiver of the indoor unit, and then repeatedly push the ON/OFF button twice.

CB012GMFI16MLD ~ CB048GMFI16MLD

The design and specifications are subject to change without prior notice for product improvement. Consult with the sales agency or manufacturer for details

202000171396
20131211